



SHUN HING GROUP  
信興集團  
SINCE 1953

**Rasonic 樂信牌**

### 信興電工工程有限公司

SHUN HING ELECTRIC WORKS AND ENGINEERING CO., LTD.

辦公室：香港九龍尖沙咀東部麼地道67號半島中心9樓909-912室

電話：2861 2767

圖文傳真：2865 6706

網址：http://www.rasonic.com

電郵：shew@shunhinggroup.com

Office: Room 909-912,9/F., Peninsula Centre, 67 Mody Road, Tsimshatsui East, Kowloon, H.K.

Tel: 2861 2767

Fax: 2865 6706

Website: http://www.rasonic.com

E-mail: shew@shunhinggroup.com

保養及維修 Maintenance and Repair Service:

### 信興電器服務中心有限公司

SHUN HING ELECTRIC SERVICE CENTRE LTD.

香港新界葵涌勝耀街2號信興中心11樓

服務熱線：2406 5666

傳真號碼：2408 0316

網址：http://www.shesc.com/zh

11/F, Shun Hing Centre, 2 Shing Yiu Street, Kwai Chung, N.T., H.K.

Service Hotline: 2406 5666

Fax No.: 2408 0316

Website: http://www.shesc.com/en

客戶服務中心：

香港新界葵涌勝耀街2號信興中心1樓

九龍佐敦佐敦道23-29號新實廣場20樓

香港天后琉璃街7號柏景中心22樓

澳門慕拉士大馬路193-199號南嶺工業大廈5樓I座

有關最新之香港及澳門客戶服務中心資料，請參閱信興服務中心網址：www.shesc.com。

Customer Service Centres:

1/F, Shun Hing Centre, 2 Shing Yiu Street, Kwai Chung, N.T., H.K.

20/F, Sino Cheer Plaza, 23-29 Jordan Road, Jordan, Kowloon, H.K.

22/F, Parkview Centre, 7 Lau Li Street, Tin Hau, H.K.

Avenida de Venceslau de Morais, No.193-199, 5 andar - I, Edf. Industrial Nam Leng, Macau

For the latest information of Hong Kong and Macau service center, please visit www.shesc.com.

**Rasonic**  
樂信牌

## RRC-YC06

迷你微電腦電飯煲

Mini Microcomputer Rice Cooker



僅供家庭使用

For household use only

## 使用說明書

## OPERATION MANUAL

- 在使用本產品前，請仔細閱讀本說明書，閱讀後小心收藏，以備日後查閱。  
Please read the operation manual carefully before using. Keep it in a safe place for future reference.
- 本說明書中的圖示可能與實物有不同的地方，僅供參考。  
The images in the operation manual may not match with the real object and are for reference only.

非常感謝您選購樂信牌迷你微電腦電飯煲，使用前請先詳細閱讀本說明書，並保存以備日後參考。

## 目錄

1. 安全注意事項
2. 清潔及儲存
3. 產品說明
4. 使用方法
5. 其他功能
6. 斷電記憶
7. 產品規格
8. 故障排除
9. 特別聲明
10. 售後服務

### 1. 安全注意事項

使用本產品時，必須遵守下列安全措施：

下圖表示由於錯誤操作而引起不同程度的危險等級。

	<b>警告</b> ：此標誌表示可能造成傷亡。
	<b>注意</b> ：此標誌表示可能造成傷害或財物損失。

以下不同標誌區分各種必須遵守的指示。

	此標誌表示 禁止。
	此標誌表示 必須遵守。

<b>警告</b>			
	切勿讓小孩單獨使用、清潔及維修保養電飯煲或把其當作玩具。請將電飯煲及其電線放於小孩不能觸及的地方。		請單獨使用額定電流10A或以上及帶接地線插座。
	切勿使用變形的內鍋，以免因與發熱板接觸不良而引致故障。		使用前，確保電源線兩端的插頭已分別插穩在電飯煲及電源插座上。
	切勿讓電飯煲在無人看管下或沒有內鍋時運作。		切勿使用有殘缺或鬆動的插座。使用前，確保插頭已充分擦乾。
	為避免燙傷，使用時或剛使用後，切勿將臉或手靠近上蓋或蒸氣口；切勿觸摸剛使用後的發熱板及內鍋，因仍有餘熱。		此電飯煲只供家庭或類似環境使用，如商店內部、辦事處和其他工作環境的員工廚房區域；旅館、汽車旅館和其他住宿類型的環境。
	使用產品後必須清潔。切勿把機身、電源線或插頭浸入水中；或被水濺濕，以免造成觸電及火災。		使用時，切勿用任何物件覆蓋電飯煲表面或遮擋蒸氣口，以免造成電飯煲故障、變形或變色。
	切勿擅自改裝電飯煲或使用非生產商提供的零件進行修理，否則可造成危險及維修保養無效。		手濕時切勿接觸、插入或拔除插頭，否則可構成觸電的危險。
	此電飯煲可供年齡在8歲或以上的兒童及體質、感覺或智力有障礙人士或缺乏經驗和相關知識的人士使用，但他們必須接受負責安全人士的監督或指導如何安全地使用電飯煲和理解所涉及的危險。		經常檢查電飯煲、內鍋、電源線及插頭，如有損壞，為避免危險，應立即停止使用，並聯絡信興電器服務中心有限公司安排檢查及維修。

<b>注意</b>			
	切勿使用其他器皿來取代原裝內鍋。		使用時，切勿打開上蓋、移動或搖晃電飯煲，以免造成危險。
	使用前，確定內鍋外部及發熱板表面清潔乾爽，否則可能引致故障。		切勿使用內鍋直接淘米，以免損害內鍋塗層，影響烹調效果。
	切勿用火加熱內鍋，否則會造成損壞。		切勿用內鍋烹調酸性或鹼性的食物，以免損壞內鍋塗層。
	煮食份量不可超過內鍋內最高水位線，否則可能有水從蒸氣口噴出。		在插入或拔除插頭時，應用手握穩插頭本身，不要抓住電源線。
	切勿在電源線纏結的情況下使用或將電源線懸掛在桌子、櫥櫃邊緣或讓它接觸發熱的表面，否則會損壞電源線。		切勿在以下環境使用電飯煲： - 潮濕或近水的環境 - 靠近熱源如焗爐、電磁爐及火源 - 不平穩的表面上 - 易燃物料或不耐熱物品附近 (如枱布、窗簾及毛巾等)
	使用後，請從電源插座拔出插頭及待電飯煲冷卻後才移動、清潔或檢查。		不可在電源線上放重物、夾住、改裝、用力拉扯或扭曲電源線。

### 2. 清潔及儲存

- 清潔前，必須拔除電源插頭，並待電飯煲完全冷卻。
- 清洗內鍋和內蓋時，請使用海綿等軟性物料及溫和清潔劑，用水沖洗後再抹乾及裝回原位。切勿用粗硬的潔具（如鋼絲刷）清潔。
- 如有食物黏在內鍋，清洗前可用清水浸泡一會。
- 如發熱板、機身或上蓋有污穢，可用濕布抹淨，再抹乾。
- 為免損壞內鍋表面塗層，盛飯時請使用原裝飯勺，切勿使用金屬餐具或在內鍋中切割食物。
- 切勿使用有毒或含腐蝕性的清潔劑進行清潔。
- 長時間使用後，內鍋表面可能會變色，但並不會影響食物安全及內鍋的使用。
- 必須待電飯煲完全冷卻及清洗後才能儲存。請放入紙箱，然後儲存在乾爽的環境中。

### 3. 產品說明

1. 蒸氣閥
2. 內鍋
3. 內蓋
4. 上蓋
5. 發熱板
6. 手柄
7. 控制面板
8. 機身
9. 開蓋按鈕

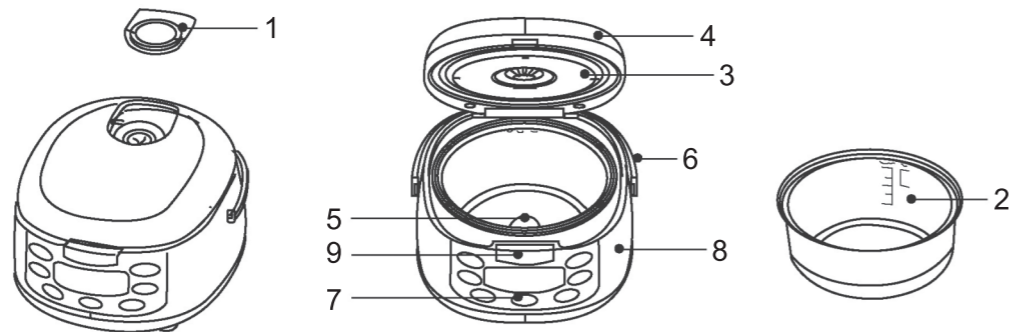

(以上產品圖片僅供參考，外觀以實物為準。)

#### 控制面板

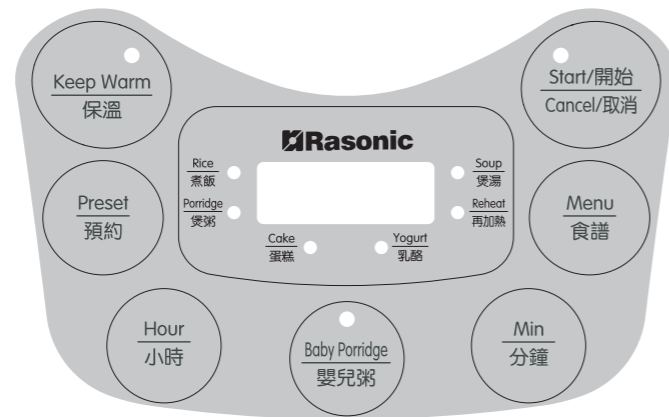

### 4. 使用方法

#### 4.1 各功能的烹調容量及時間

烹調功能	烹調最少份量	烹調最多份量	默認煮食時間	煮食時間	保溫	預約
煮飯	1杯米	4杯米	不適用	35-50分鐘 (不可調校)	✓	✓
煲粥	1/2杯米	3/4杯米	1小時30分鐘	1-4小時	✓	✓
蛋糕	請根據說明書食譜		50分鐘	10-60分鐘	✓	X
乳酪	“白米”刻度1	“白米”刻度4	8小時	6-12小時	X	X
再加熱	“白米”刻度1	“白米”刻度4	25分鐘	25-90分鐘	X	X
煲湯	“白米”刻度1	“白米”刻度4	1小時30分鐘	1-4小時	✓	✓
嬰兒粥	1/2杯米	3/4杯米	1小時30分鐘	1-4小時	✓	✓

※ 煮飯的實際時間會根據米量、水量、電壓、室溫、水溫及米質的不同而變化。  
 ※ 米飯的軟硬程度會因米量、水量及米質的不同而受到影響，並有可能產生鍋巴。

#### 4.2 基本功能 - 煮飯 / 煲粥 / 煲湯 / 嬰兒粥



1. 請使用原裝量杯量米，1杯米平口盛滿，約一人食用量。
2. 洗米及加水
  - (1) 將清洗乾淨的米倒入內鍋。請勿在內鍋直接洗米，避免磨擦內鍋塗層。
  - (2) 加入適量的水。如煮2杯米的白飯份量，加水至“白米”水位線刻度2的位置。如煮1/2杯米的粥份量，加水至“粥”水位線刻度1/2的位置。
    - ※ 用戶可按個人口感的喜好適當地調節水量。
    - ※ 切勿用熱水煮飯，否則會影響溫控器的運作及米飯的口感。
    - ※ 請確保鍋內的米要均勻分佈。
3. 將內鍋放入電飯煲主體中。
  - (1) 放入內鍋前，請確保內鍋外側及底部已抹乾和清潔；如發熱板表面有異物，應立刻清除，否則煮食時會有異聲及可能造成故障。
  - (2) 將內鍋平放於電飯煲本體內及確保內鍋與發熱板充分接觸。
4. 關上上蓋，直至聽到“咔答”一聲。
5. 連接電源，電飯煲會發出一聲蜂鳴響，顯示屏出現“----”及開始指示燈會閃動，表示進入待機狀態。
6. 按【食譜】鍵選擇功能，直至所需功能的指示燈亮起及顯示屏出現默認煮食時間(煮飯功能除外)。按【開始/取消】鍵啟動功能，開始指示燈會長亮。
  - ※ 如烹調嬰兒粥，可直接按【嬰兒粥】鍵，再按【開始/取消】鍵啟動功能。
  - ※ 除煮飯功能外，用戶可按【時間】及【分鐘】鍵調校煮食時間。
7. 烹調完成時，電飯煲會發出蜂鳴響。開始指示燈會熄滅，而保溫指示燈會亮起，表示電飯煲進入保溫狀態。
  - ※ 轉保溫後，建議讓米飯在電飯煲內蒸焗10-15分鐘才食用，這樣米飯會更加鬆軟可口。
8. 當不使用電飯煲時，必須拔除電源插頭。

#### 4.3 蛋糕

~ 參考食譜 ~

蛋糕	
雞蛋	3隻(中)
低筋麵粉	90克
牛油	30克
糖	80克

使用蛋糕功能前，請預先準備好蛋糕糊才倒進內鍋進行烹調。

準備蛋糕糊：

1. 將牛油隔溫水溶化。
2. 將糖分兩至三次加入蛋漿內，並隔溫水(約38°C)用打蛋器攪拌，直至形成挺身及幼細的泡沫。
  - ※ 請確保糖在發打過程中已充分溶化。
3. 將低筋麵粉過篩撒在蛋漿表面，用膠製刮刀輕柔及快速地攪拌，以保持氣泡在蛋糊內，直至均勻。

設定電飯煲：

1. 取出內鍋，將一層牛油均勻地塗在內鍋內壁上，然後將蛋糕糊倒進內鍋內。
2. 用膠製刮刀將蛋糕糊表面撫平。將內鍋放回電飯煲主體內及關上上蓋。
3. 按【食譜】鍵選擇蛋糕功能，蛋糕指示燈會亮起及顯示屏會出現默認煮食時間。如有需要，可調校煮食時間。
4. 按【開始/取消】鍵啟動功能，開始指示燈會長亮。
5. 烹調完成時，電飯煲會發出嗶嗶聲及轉為保溫狀態，請按【開始/取消】回到待機狀態，並拔出電源插頭。
6. 從內鍋倒出蛋糕，冷卻約10分鐘後便可享用。

**4.4 乳酪**

~ 參考食譜 ~

乳酪	
乳酪(含乳酸菌)	125毫升
牛奶	1000毫升
糖	30克 (2湯匙)

提示：新鮮乳酪因沒添加防腐劑，請存放在雪櫃冷藏及盡快享用。

設定電飯煲：

1. 取出內鍋，並用100度熱水消毒內鍋。
2. 將材料倒進內鍋內，再把內鍋放回電飯煲主體內及關上上蓋。
3. 按【食譜】鍵選擇乳酪功能，乳酪指示燈會亮起及顯示屏會出現默認煮食時間。如有需要，可調校煮食時間。
4. 按【啟動/取消】鍵啟動功能，開始指示燈長亮。
5. 烹調完成後，電飯煲會發出嗶嗶聲，請按【開始/取消】回到待機狀態，並拔出電源插頭。
6. 取出內鍋，用膠製刮刀將乳酪取出。  
※ 此功能完成烹調後沒有保溫功能。

**4.5 再加熱**

此功能可用於翻熱食物如冷飯、粥或湯。

設定電飯煲：

1. 將食物倒入內鍋。
2. 將約1/2杯至1杯水灑在食物上，並用飯勺翻鬆食物，然後關上上蓋。
3. 按【食譜】鍵選擇再加熱功能，再加熱指示燈會亮起及顯示屏會出現默認煮食時間。如有需要，可調校煮食時間。
4. 按【啟動/取消】鍵啟動功能，開始指示燈長亮。
5. 烹調完成後，電飯煲會發出嗶嗶聲，請按【開始/取消】回到待機狀態，並拔出電源插頭。  
※ 此功能完成後沒有保溫功能。

**5. 其他功能****5.1 保溫功能**

1. 在待機狀態下，按【保溫】鍵可啟動保溫功能，保溫指示燈會亮起。
2. 保溫功能啟動後，顯示窗會累計保溫時間。
3. 保溫時，請將米飯翻鬆，並將上蓋關上，以免米飯變乾及結塊。
4. 保溫時間不要超過5小時，否則米飯可能會變色，產生異味或鍋巴。
5. 如不需要保溫時，請按【開始/取消】鍵停止保溫，並拔除電源插頭。

**5.2 預約功能**

用戶可用此功能設定電飯煲完成烹調的時間，預約功能只適用於煮飯、煲粥、煲湯及嬰兒粥功能。

1. 接通電源，按【食譜】鍵選擇功能，所選功能的指示燈會亮起及顯示屏會出現默認煮食時間。
2. 按【預約】鍵進入預約功能。
3. 按【小時】鍵及【分鐘】鍵設定預約完成烹調的時間，每按一次【小時】鍵或【分鐘】鍵，分別會增加1小時或5分鐘，長按【小時】鍵及【分鐘】鍵可以快速遞增時間值。
4. 設定後，按【開始/取消】鍵啟動預約功能。
5. 電飯煲會處於待機狀態，直至倒數至功能的默認煮食時間，才會開始烹調。  
※ 預約功能是以24小時制式設定，最長設定為24小時後完成烹調。  
※ 建議預約時間不要超過12小時，以免食物變質及產生異味。  
※ 如預約完成時間少於所選功能之默認煮食時間，按【開始/取消】鍵後，電飯煲會立即啟動。

**6. 斷電記憶**

如使用途中，出現供電不正常、插頭被不小心拔掉或需移動電飯煲等情況，用戶只需在2小時內重新連接電源，便可繼續斷電前的功能。

**7. 產品規格**

型號	RRC-YC06
額定電壓	220-240伏特~ 50/60赫茲
額定功率	400-480瓦
容量	約0.64升 (最多4杯米)
淨重	2.1 公斤
產品尺寸 (闊x 深 x 高)	220 x 270 x 204毫米

**8. 故障排除**

故障現象	原因	解決方法
1. 指示燈不亮。	電源尚未連接穩妥。	檢查插頭、插座及電源線是否完好，以及是否完全插入插座。
	電源插頭或內部零件損壞。	請聯絡信興電器服務中心有限公司檢查及維修。
2. 指示燈亮起，發熱板不熱。	內部零件或發熱板零件損壞。	請聯絡信興電器服務中心有限公司進行檢查及維修。
3. 飯煮不熟。	米量及水量的比例不正確。	調整米量及水量的比例。
	發熱板變形或內部零件損壞。	請聯絡信興電器服務中心有限公司進行檢查及維修。
	內鍋未有適當地放於發熱板上。	將內鍋輕輕轉動直至與發熱板充分接觸。
4. 米飯煮焦。	內鍋與發熱板之間有異物影響接觸。	清除異物。
	米量過多或水量過少。	增加適量的米或水。
5. 煮粥時溢出。	內部零件損壞。	請聯絡信興電器服務中心有限公司檢查及維修。
	米量或水量過多。	減少適量的米或水。
6. 顯示屏出現E1、E2、E3或E4。	電路板出現故障。	請聯絡信興電器服務中心有限公司檢查及維修。
7. 設定預約功能後，按【開始/取消】鍵立即開始烹調，並沒有等待過程。	設定的完成時間少於功能的默認烹調時間。	請參考“預約功能”並重新設定電飯煲。
8. 沒有在預約的時間完成煮飯功能。	沒有按【開始/取消】鍵啟動預約功能。	按【開始/取消】鍵啟動預約功能。
9. 煮飯時，電米飯煲發出“咔嗒”聲。	這是溫控器自動調整火力的聲音，屬正常現象。	電飯煲是安全的，可繼續使用。

如使用以上方法後仍未能使電飯煲回復正常操作，請聯絡信興電器服務中心有限公司進行檢查及維修。

## 9. 特別聲明

1. 此說明書所有內容經過核對，如有任何印刷錯誤或內容上的誤解，本公司將保留解釋權。
2. 本產品若有技術改進，會編進新版說明書中，恕不另行通知；產品外觀及規格以廠方資料為準。
3. 此說明書的電子副本可透過電子郵件發送致客戶。如有需要，請致電28612767聯絡信興電工工程有限公司。

## 10. 售後服務

由購買收據日期起之一年保修期內，經信興電器服務中心有限公司之服務人員證實產品故障屬正常使用下發生者，本公司將提供免費維修或更換零件服務。經更換之任何損壞零件，將歸屬本公司所有。保修範圍不包括修理或更換損耗性零件如飯勺及內鍋等。如不當使用，或作為(半)商業用途，或未依照說明書使用，保修服務將無效，本公司將不會承擔任何損壞的維修責任及賠償。

用戶必須於維修時出示購買 / 換購收據及蓋有銷售點 / 換購中心印章的保修證(印刷在包裝盒上)，如有任何疑問，請致電信興電器服務中心有限公司熱線查詢：2406 5666。

Thank you for choosing Rasonic Mini Microcomputer Rice Cooker. Please read the operation manual carefully before use and keep it for your future reference.



## Table of Contents

1. Important Safeguards
2. Cleaning and Storage
3. Product Description
4. Operation Instructions
5. Other Functions
6. Power Cut-Off Memory
7. Product Specification
8. Troubleshooting
9. Special Avowal
10. After Sales Service



### 1. Important Safeguards















When using the appliance, please follow the below safety precautions:













The following chart indicates the degree of damage caused by wrong operation.

 <b>WARNING:</b> Indicates that may cause death or serious injury.
 <b>CAUTION:</b> Indicates hazards that may cause human injuries or property damages.

The following symbols can distinguish the instruction types that need to be strictly followed.

 These symbols mean prohibition.
 These symbols mean requirement that must be followed.

 <b>WARNING</b>			
	Never allow children to operate, clean or perform maintenance on the appliance alone or play as toy. Please put the appliance and its power cord in a place not reachable by children.		Please use an individual socket with rated current 10A or above and earth wire.
	Do not use deformed inner pot to avoid malfunction due to poor contact with heating plate.		Before use, please make sure both ends of the power cord are plugged in tightly on the appliance and the power socket.
	Never leave the appliance unattended when in use or operate without inner pot.		Do not use deficient or loosen socket. Make sure the plug is dry before use.
	To avoid burn, do not get your face or hands close to the lid or steam vent during use or right after use; never touch the heating plate and inner pot which are subject to residual heat right after use.		The appliance is intended to be used in household or similar applications such as staff kitchen in shops, office and other working environments; by clients in hotels, motels and other residential type environments.
	Clean the appliance after use. Never immerse the main body, power cord or plug in water or let them wet, it can cause electric shock or fire.		When in use, do not cover the appliance surface or steam vent with any objects to avoid appliance malfunction, deformation or discoloration.
	Do not attempt to modify the appliance by yourself or repair with any unauthorized parts, otherwise it will cause hazards and the warranty will become invalid.		Do not touch, plug in or remove the plug with wet hands, it can cause electric shock.
	The appliance can be used by children aged from 8 years and above and persons with reduced physical, sensory or mental capabilities, or lack of experience and knowledge, if they have given supervision or instruction concerning use of the appliance in a safe way and understand the hazards involved.		Always check the condition of rice cooker, inner pot, power cord and plug. To avoid hazard, stop using the appliance immediately and contact Shun Hing Electric Service Centre Limited for checking and repairing if any part is damaged.

 <b>CAUTION</b>			
	Do not use other container to substitute the original inner pot.		Do not open the lid, move or shake the appliance when in use, it can cause danger.
	Make sure the inner pot outer surface and heating plate are clean and dry before use, otherwise it may cause malfunction.		Do not wash rice directly inside the inner pot to avoid scratching the coating and affect the cooking results.
	Do not heat the inner pot with fire, it will cause damage.		Do not cook acidic or alkaline food in the inner pot to avoid damage on the inner pot coating.
	The cooking amount cannot exceed the maximum water level of the inner pot to prevent water from spilling from the steam vent.		Grasp the plug itself when plug in or unplug the appliance, do not grasp the power cord.
	Do not operate the appliance when the power cord is tangle or hang the power cord over the edge of a table, counter-top or let it touch any hot surface, it may damage the power cord.		Do not operate the appliance in the following places: <ul style="list-style-type: none"> <li>- Humid environment or near water</li> <li>- Near heat sources such as electric oven, induction cooker and fire</li> <li>- Unstable surface</li> <li>- Near inflammable or non-resistant to heat objects (e.g. table cloth, curtain and towel etc.)</li> </ul>
	After use, please unplug the appliance and let the appliance cool down before moving, cleaning or checking.		Do not place heavy objects on the power cord. Never clip, modify, stretch or twist the power cord.

### 2. Cleaning and Storage

1. Before cleaning, the plug must be removed and let the rice cooker cool down completely.
2. When clean the inner pot and inner lid, please use soft material such as sponge and mild detergent to clean. Rinse with water and rub them dry. Put them in place after cleaned. Never clean with harsh cleaning tools (e.g. metal-wired brush).
3. If food residues stick on the inner pot, please soak the inner pot for a while before cleaning.
4. If dirt is attached on the heating plate, main body or lid, use a damp cloth to clean and wipe them dry.
5. To avoid damage on the inner pot coating, please use original rice scoop when serving rice, never use metal utensils or cut food in the inner pot.
6. Never use poisonous or corrosive detergent for cleaning.
7. The color of inner pot may change after using some time, however it does not affect the food hygiene and function of the inner pot.
8. Always let the rice cooker cool down completely and cleaned before storage. Put it in a box and store in a dry place.

### 3. Product Description

1. Steam vent
2. Inner pot
3. Inner lid
4. Lid
5. Heating plate
6. Handle
7. Control panel
8. Main body
9. Lid-open button

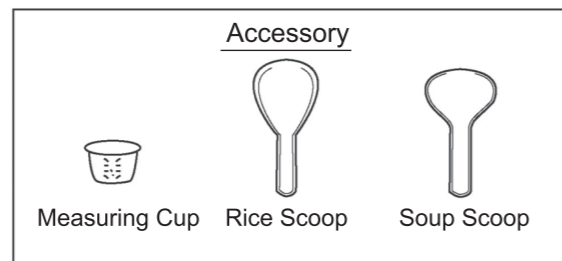
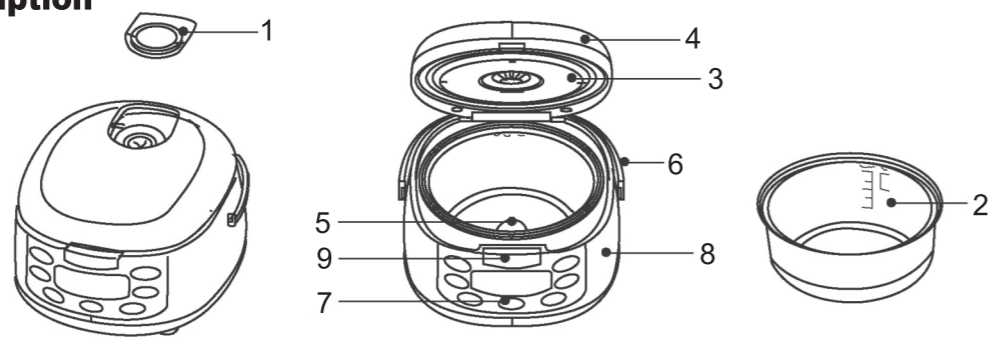

(Above product drawing is for reference only, appearance please refers to actual product.)

#### Control Panel

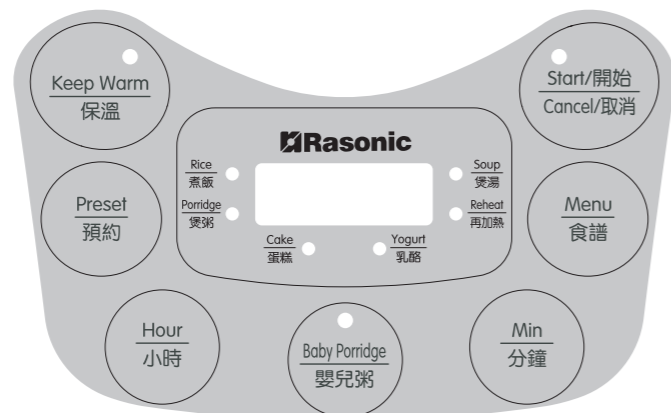

### 4. Operation Instructions

#### 4.1 The cooking amount and time of each function

Function	Min. amount of cooking	Max. amount of cooking	Default cooking time	Cooking time	Keep warm	Preset
Rice	1 cup of rice	4 cups of rice	Not applicable	35-50 mins. (non-adjustable)	✓	✓
Porridge	1/2 cup of rice	3/4 cup of rice	1 hr 30 mins.	1-4 hrs.	✓	✓
Cake	Please refer to the recipe		50 mins.	10-60 mins.	✓	X
Yogurt	“白米” (Rice) marking 1	“白米” (Rice) marking 4	8 hrs.	6-12 hrs.	X	X
Reheat	“白米” (Rice) marking 1	“白米” (Rice) marking 4	25 mins.	25-90 mins.	X	X
Soup	“白米” (Rice) marking 1	“白米” (Rice) marking 4	1 hr 30 mins.	1-4 hrs.	✓	✓
Baby porridge	1/2 cup of rice	3/4 cup of rice	1 hr 30 mins.	1-4 hrs.	✓	✓

※ The actual rice cooking time is varied with different rice amount, water volume, voltage, room temperature, water temperature and rice quality.

※ The rice texture is affected by different rice amount, water volume and rice quality which may form crust.

#### 4.2 Basic Functions - Rice / Porridge / Soup / Baby porridge



1. Please use the original measuring cup, one full cup of rice is approximately for one person.
2. Wash rice and add water
  - (1) Put the rinsed rice in the inner pot. Do not wash rice directly inside the inner pot to avoid scratching the coating.
  - (2) Add suitable amount of water. To cook 2 cups of rice, please add water until reaching marking 2 on the “白米” (Rice) indication line. To cook 1/2 cups of porridge, please add water until reaching marking 1/2 on the “粥” (Congee) indication line.
    - ※ The water amount can be adjusted according to personal preference on the rice texture.
    - ※ Do not cook with hot water, it will affect the thermostat operation and the rice texture.
    - ※ Make sure the rice is evenly distributed in the inner pot.
3. Put the inner pot in the main body.
  - (1) Before putting the inner pot, make sure the outer and bottom surface of the inner pot is wiped dry and clean. If foreign substance is attached on the heating plate, please remove it immediately. Otherwise, it will cause noise while cooking and possibly a malfunction.
  - (2) Put the inner pot in the main body and ensure it is directly in contact with the heating plate.
4. Close the lid until a “click” sound is heard.
5. Connect the power, a beep sound will be heard. The display screen will show “----” and the start indication light will flash, which indicate the appliance is in stand-by mode.
6. Press **[Menu]** key to select the function until the indication light of the desired function is on and the display screen will show the default cooking time (except the rice cook function). Press **[Start/Cancel]** key to start the cooking process and the start indication light will keep on.
  - ※ To cook baby porridge, press **[Baby Porridge]** key directly, then press **[Start/Cancel]** key to start the cooking process.
  - ※ Except rice-cook function, the cooking time is adjustable by pressing **[Hour]** and **[Min]** key.
7. When cooking is completed, beep sounds will be heard. The start indication light will be off and the keep warm indication light will turn on which means the rice cooker is in keep warm status.
  - ※ After changing to keep warm status, you may keep the rice in the rice cooker for 10-15 minutes, the rice would become softer and taste better.
8. When the rice cooker is not in use, please unplug it from the power socket.

#### 4.3 Cake

~ Recipe for reference ~

Cake	
Egg	3 pcs (medium size)
Low-gluten flour	90g
Butter	30g
Sugar	80g

Before using the cake function, please prepare the cake batter and pour into the inner pot for cooking. Prepare the cake batter:

1. Melt the butter in a bowl bathed in warm water.
2. Add sugar into the egg in 2 to 3 times, use a hand mixer to beat the egg mixture in a bowl bathed in a warm water (about 38°C) until it becomes stiff and fluffy.
  - ※ Make sure the sugar is well blended and melted in the mixture.
3. Sift the low-gluten flour over the egg mixture. Stir it gently and quickly by a rubber spatula in order to keep the air in the mixture. Blend the mixture until well combined.

Set the rice cooker:

1. Take out the inner pot and spread a butter layer on the inner pot cavity evenly. Then pour the cake batter into the inner pot.
2. Use a rubber spatula to make the surface of cake batter flat. Put the inner pot in the main body and close the lid.
3. Press **[Menu]** key to select cake function, the cake indication light will be on and the display screen will show the default cooking time. Set the cooking time if needed.
4. Press **[Start/Cancel]** key to start the cooking process and the start indication light will keep on.
5. When cooking is completed, beep sounds will be heard and rice cooker will turn to keep warm status. Press **[Start/Cancel]** key to return to stand-by mode, then remove the plug.
6. Remove the cake from the inner pot and let it cool down for 10 minutes before served.

#### 4.4 Yogurt

~ Recipe for reference ~

Yogurt	
Yogurt (with live cultural bacteria)	125ml
Milk	1000ml
Sugar	30g (2 tablespoon)

Hint: The fresh yogurt has no preservative, please freeze it in refrigerator and consume as soon as possible.

Set the rice cooker:

1. Take out the inner pot and sterilize the inner pot with 100°C hot water.
2. Put the ingredients into inner pot. Put the inner pot in the main body and close the lid.
3. Press **【Menu】** key to select yogurt function and the indication light will be on and the display screen will show the default cooking time. Set the cooking time if needed.
4. Press **【Start/Cancel】** key to start the cooking process and the start indication light will keep on.
5. When cooking is completed, beep sounds will be heard. Press **【Start/Cancel】** key to return to stand-by mode, then remove the plug.
6. Take out the inner pot and use a rubber spatula to remove the yogurt.  
※ Keep warm is not available for yogurt function.

#### 4.5 Reheat

This function can reheat food such as cold rice, congee or soup.

Set the rice cooker:

1. Put the food in the inner pot.
2. Spray around 1/2 to 1 cup water on the food and loose it by rice scoop. Close the lid.
3. Press **【Menu】** key to select reheat function, the reheat indication light will be on and the display screen will show the default cooking time. Set the cooking time if needed.
4. Press **【Start/Cancel】** key to start the cooking process and the start indication light will keep on.
5. When cooking is completed, beep sounds will be heard. Press **【Start/Cancel】** key to return to stand-by mode, then remove the plug.  
※ Keep warm is not available for reheat function.

### 5. Other Functions

#### 5.1 Keep warm function

1. In the stand-by mode, keep warm function can be operated by pressing the **【Keep Warm】** key and the keep warm indication light will be on.
2. When keep warm function is activated, the display screen will show the accumulated keep warm time.
3. To avoid the rice become dry and clamp, please scarify the rice and keep the lid closed tightly during keep-warm.
4. Do not keep warm over 5 hours, otherwise the rice may change color, generate odour or form crust.
5. To quit the keep warm function, press **【Start/Cancel】** key, then remove the plug.

#### 5.2 Preset function

User can use the preset function to set the cooking completion time. It is only applicable for rice, porridge, soup and baby porridge function.

1. Connect the power, press **【Menu】** key to select the function, the indication light of the selected function will be on and the display screen will show the default cooking time.
2. Press **【Preset】** key to enter the preset procedure.
3. Press **【Hour】** key and **【Min】** key to set the cooking completion time. One press of **【Hour】** key or **【Min】** key will increase the cooking time by 1 hour or 5 minutes respectively. Long press **【Hour】** key or **【Min】** key, the time digit will increase quickly.
4. After set, press **【Start/Cancel】** key to start the preset function.
5. The rice cooker will be in the stand-by mode and start cooking until it counts down to the function default cooking time.  
※ The preset function is 24 hour setting. The maximum setting is to finish cooking after 24 hours.  
※ Do not preset the time over 12 hours to avoid food deterioration and bad smell.  
※ If the preset completion time is less than the default cooking time of the selected function, the appliance will start immediately after pressing the **【Start/Cancel】** key.

### 6. Power Cut Off Memory

Under the situation of abnormal power supply, plug being removed by accident or moving the rice cooker during operation, the rice cooker can resume the process if it is re-connected to the power within 2 hours.

### 7. Product Specification

Model	RRC-YC06
Rated Voltage	220-240V~ 50/60 Hz
Rated Power	400-480W
Capacity	Approx. 0.64L (Max. 4 cups of rice)
Net Weight	2.1 kg
Product Size (W x D x H)	220 x 270 x 204mm

### 8. Troubleshooting

Problem	Cause	Solution
1. Indication light is not on.	The power source is not connected properly.	Check whether the plug, socket and the power cord is in good condition and make sure the plug is firmly inserted into the socket.
	The plug or the internal parts are damaged.	Please contact Shun Hing Electric Service Centre Ltd. for checking and repairing.
2. Indication light is on but the heating plate is not heated.	The internal parts or the heating plate is damaged.	Please contact Shun Hing Electric Service Centre Ltd. for checking and repairing.
3. Rice is under-cooked.	The proportion of rice to water is incorrect.	Adjust the amount of water to rice with the correct proportion.
	Heating plate is deformed or the internal parts are damaged.	Please contact Shun Hing Electric Service Centre Ltd. for checking and repairing.
	The inner pot sits improperly on the heating plate.	Slightly turn the inner pot left and right until it fully contacts with the heating plate.
	There are foreign objects between the inner pot and heating plate.	Remove the foreign objects.
4. The rice is burnt.	Too many rice or too little water is added.	Add proper amount of rice or water.
	The internal parts are damaged.	Please contact Shun Hing Electric Service Centre Ltd. for checking and repairing.
5. The porridge overflowed.	Too much rice or water is added.	Reduce proper amount of water or rice.

Problem	Cause	Solution
6. Display screen shows E1, E2, E3 or E4.	There is PCB failure.	Please contact Shun Hing Electric Service Centre Ltd. for checking and repairing.
7. After set the preset function and press the <b>【Start/Cancel】</b> key, the appliances starts to cook immediately without stand-by process.	The preset completion time is shorter than the default cooking time of the selected function.	Please refer to “Preset function” to reset the rice cooker.
8. The appliance fails to complete the cooking process according to the preset setting.	Forget to press <b>【Start/Cancel】</b> key to start the preset function.	Press <b>【Start/Cancel】</b> key to start the preset function.
9. Ticking sound is coming from the rice cooker.	The sound is produced when the thermostat is adjusting the temperature which is normal.	The appliance is safe to use.

If the above solutions cannot fix the problem, please contact Shun Hing Electric Service Centre Ltd. for checking and repairing.

### 9. Special Avowal

1. The content in the operation manual has been checked. Our company reserves the hermeneutic power to any printing errors or misunderstanding on the content.
2. If there are technical improvements on the appliance, the operation manual will be updated in new version without prior notice. The product appearance and specification are subject to the manufacturer information.
3. The e-copy of user manual can be sent by email on requested. For enquiries, please call Shun Hing Electric Works & Engineering Co., Ltd. hotline at 2861 2767.

### 10. After Sales Service

For any defect, in the judgment of technician from Shun Hing Electric Service Centre Limited, caused under normal use, our company is responsible for repairing or replacing any parts of the said electrical appliance free of charge within one year guarantee period commencing from the date of purchase. Any defective part which has been replaced shall become our property. Warranty service does not cover the repair or replacement of consumable parts such as rice scoop and inner pot etc. If the appliance is used improperly, for commercial or semi-commercial use, or not following the instructions in the operation manual, the warranty becomes invalid and our company will refuse any liability and repairing cost for the damage caused.

User must present the official invoice / redemption voucher and the warranty card (printed on packing box) with the chop from sales point / redemption center for maintenance. For enquiries, please call Shun Hing Electric Service Centre Limited hotline at 2406 5666.